

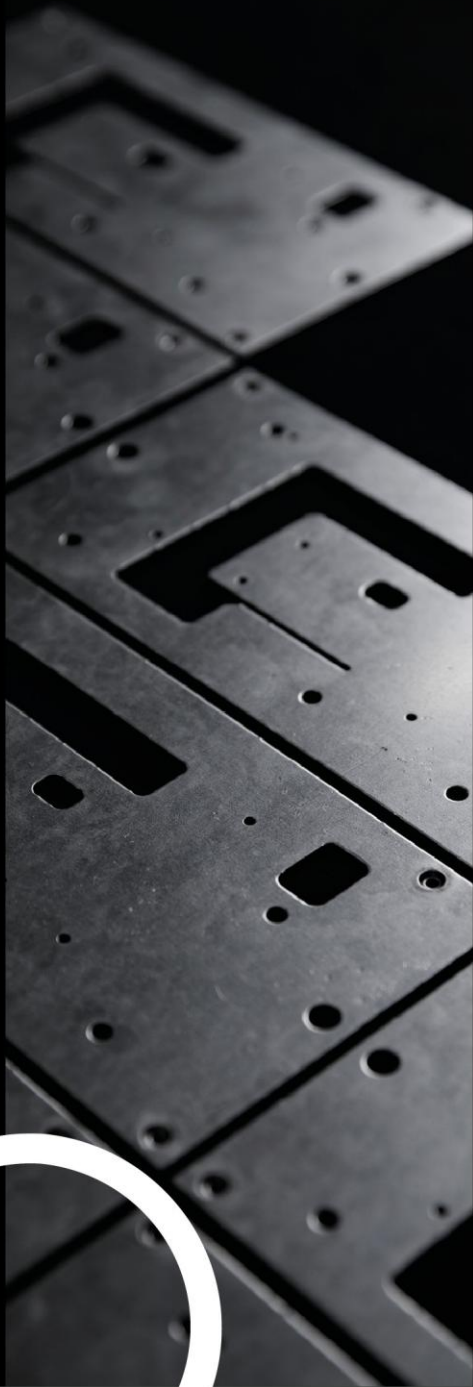

TopSolid
2026



What's New
TopSolid 6.27



2026, **TOPSOLID SAS**.
7, Rue du Bois Sauvage
F-91055 Évry, France
Web: www.topsolid.com

All rights reserved.

TopSolid® is a registered trademark of **TOPSOLID SAS**.

TopSolid® is a product name of **TOPSOLID SAS**.

The information and the software contained within this document are subject to change without prior warning and should not be construed as a commitment by **TOPSOLID SAS**.

The software covered by this document is supplied under license and may only be used and duplicated in compliance with the terms of this license.

Hard copy or digital materials provided during training or accessible on-line as part of the training represent a protected original work that is the property of the training organization. They cannot be reproduced in part or in full without the express consent of the training organization.

All the texts, comments, works, illustrations and images reproduced on these materials are protected by copyright worldwide. Any use other than that designed for the purposes of training is subject to the prior authorization of the training organization, subject to prosecution. The Customer shall refrain from using, reproducing, representing, lending, exchanging, transmitting or transferring and more generally exploiting all or part of the documents without the prior written consent of **TOPSOLID SAS**. The Customer shall also refrain from extracting all or part of the data and/or transferring it to another material, and from modifying, adapting, arranging or transforming it without the prior written consent of the training organization. The Customer is only granted a right of use, to the exclusion of any transfer of ownership in any form whatsoever. Therefore, only the reproduction and representation of the content authorized by the French Intellectual Property code on a screen, and a single hard copy for archiving purposes, are authorized, for strictly personal purposes, and for professional use.

The Customer also undertakes to not take part in competing, directly or indirectly, with the training organization by transferring or communicating these documents to anyone.

Version 6.27

Rev. 01

Note: If you are experiencing problems using this document, please feel free to send your feedback and comments to edition@topsolid.com.

Tip:
Any questions about TopSolid? Find the answers you need in our comprehensive [TopSolid'Faq!](#) It's your go-to resource for solutions to the most common queries.
Elevate your skills with TopSolid'Learning. Ready to take your skills to the next level? Whether you're a beginner or looking to sharpen your expertise, our online platform, [TopSolid'Learning](#) is designed to help you grow. Learn at your own pace and unlock the full potential of our software, making it an essential part of your projects.

Contents

- Welcome to TopSolid 2026 1**
- What's New in TopSolid'Wood 2**
 - Usability 2
 - Interfaces 22

Welcome to TopSolid 2026

Discover a new level of performance and innovation with **TopSolid 6.27!**

Designed to enhance your daily workflow, this latest generation of **TopSolid** offers exceptional power, smooth operation and intelligent features to optimize the design, manufacturing and management of your industrial projects.

Benefit from new features, significant improvements, and a redesigned user experience—all developed to increase your productivity and simplify your design and manufacturing processes.

To learn more and quickly get up to speed with these innovations, contact your local agency for personalized support and guidance.

TopSolid v6 Products at the Core of Innovation

- **TopSolid'Wood** (on page 2): The dedicated CAD/CAM solution for woodworking professionals—designed to model, organize, and manufacture your furniture and interior fittings efficiently and reliably.
- **TopSolid'Sheetmetal** (on page 23): The all-in-one CAD/CAM solution for sheet metal, providing all the necessary tools to design and produce sheet-metal parts quickly, accurately, and with complete process integration.

What's New in TopSolid'Wood

Usability

Quick search and command execution

The new quick search feature lets you find and run any command without browsing through menus.

Note: This feature is especially helpful for accessing commands you use infrequently or whose location you do not remember.

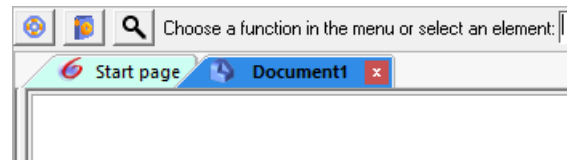

1. In neutral mode, click on the magnifying glass icon.
2. Enter a few letters of the command name in the search bar, then press **Tab** to start the search.
3. **TopSolid** immediately displays the matching commands.
4. Click on the command or press **Enter** to run it.

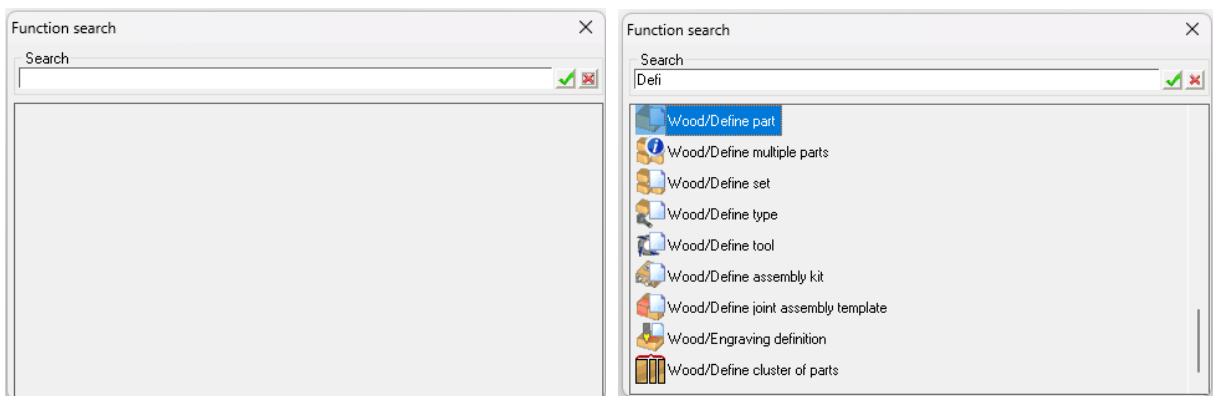

The selected command is executed right away, helping you save time while navigating.

Automatic process verification

The new **Verify process** command displays a list of components whose processes have not been executed in the document where they are included.

Note: Sub-components of components are not shown in this list.

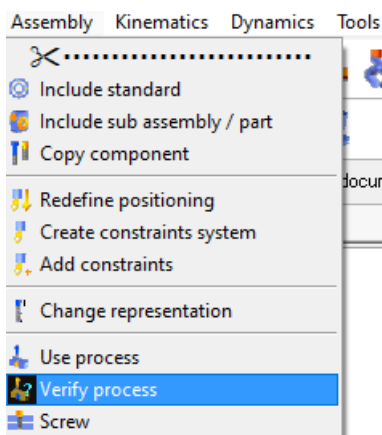

When you run the command, **TopSolid** analyzes components that contain processes and displays those whose processes have not been executed.

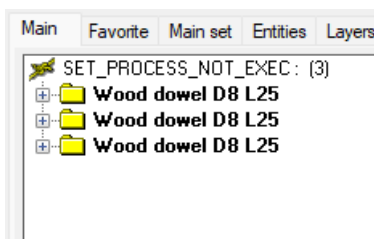

Important: This command does not list missing operations on parts. It only includes processes that have not been created on the operating component.

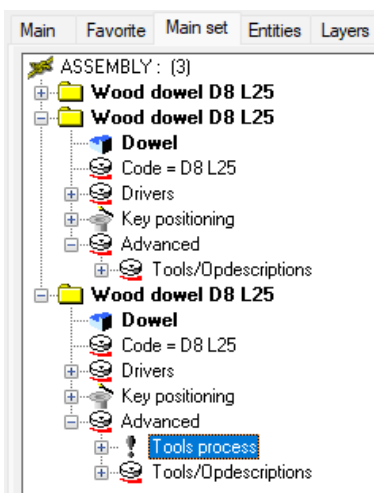

Automatic process generation

The new contextual **Use process** command, accessible directly from the verification results, allows you to automatically generate processes for all identified components.

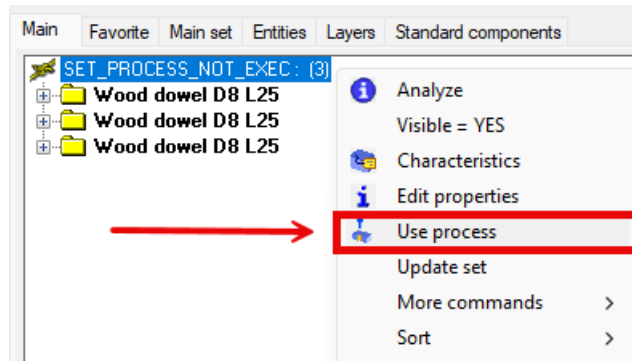

Behavior

If a component's process fails, processing automatically continues with the next component. The failed process remains listed for later review.

At the end of the operation, the tree is recalculated to show both the status of the generated processes and those that still need to be executed.

Note: This feature automates batch processing while providing clear and immediate traceability of components that have not been processed.

Guided distribution wizard

A new wizard integrated into the distribution command now allows for quick, reliable, and fully guided placement of a distribution through a series of simple steps.

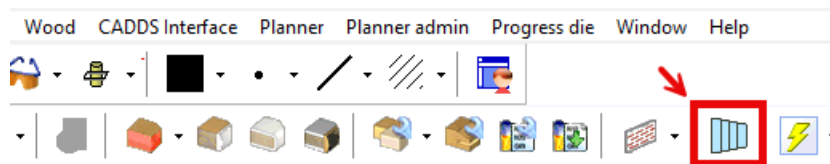

Behavior

From the distribution command, select the **Wizard** option after defining the distributed block values. This will start a step-by-step workflow.

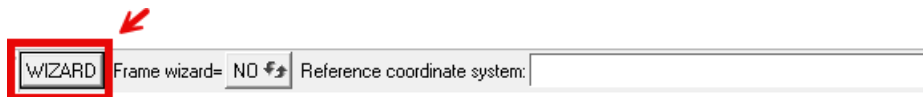

You will then be prompted to define, in order:

- a ground face and its offset (measured along the face normal),
- a wall face and its offset (also measured along the face normal),
- the left side,
- the right side.

After you set these four parameters, the distribution is automatically generated based on the defined references. Since offsets are calculated along the normals of the selected faces, positioning remains consistent, precise, and independent of the geometry.

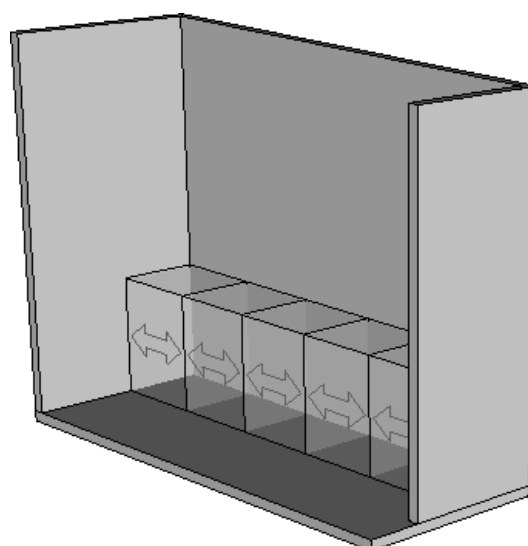
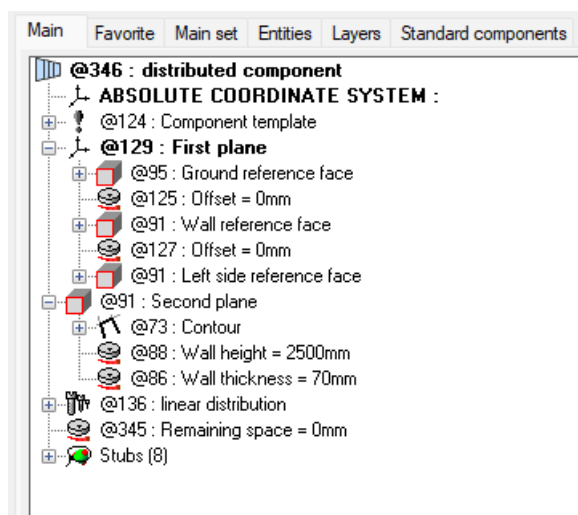

Note: This wizard enables you to accurately place a distribution in just a few steps, without manually managing constraints, while ensuring reliable, repeatable, and much faster input.

Defining a coordinate system as an auxiliary element in neutral mode

You can now define a coordinate system as an auxiliary element directly in neutral mode. Click on the coordinate system to display the corresponding option immediately.



Automatic retention of the Standard filter

The **Filter Standard** option, when activated from the tree, is now saved automatically.

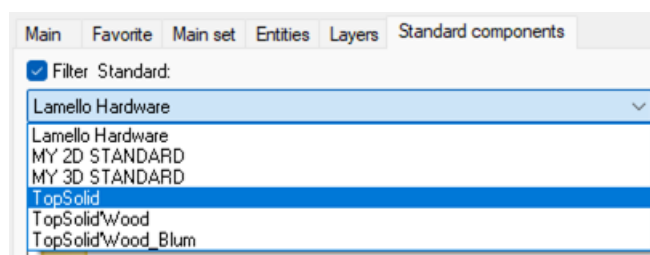

The filter state is retained in the following situations:

- when you reopen a document,
- after closing and restarting the software,
- and for all documents opened afterwards.

Note: This retention is global: the filter remains active for all documents until you manually deactivate it.

Matter and coating filtering at document level

You can now apply a specific filter for matters and coatings directly in the document properties, independently of the global settings defined in **Tools > Options**.

Note: This filtering only affects the current document. Click on the **Reset** button to instantly restore the default filters.

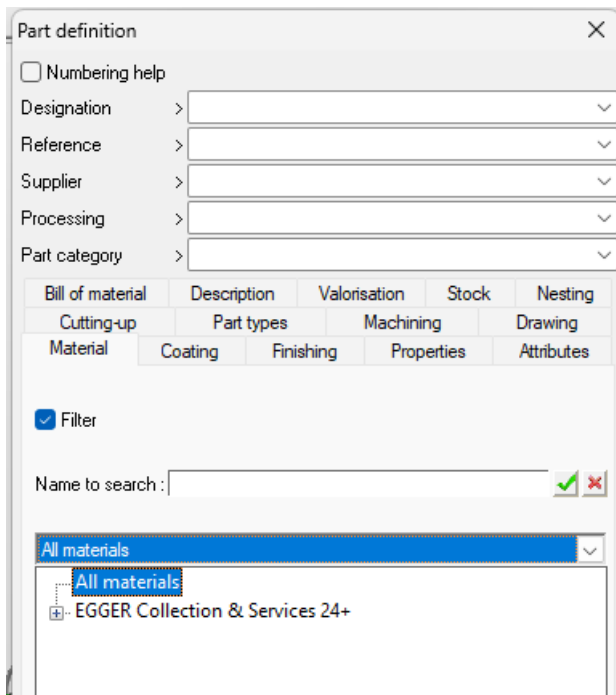
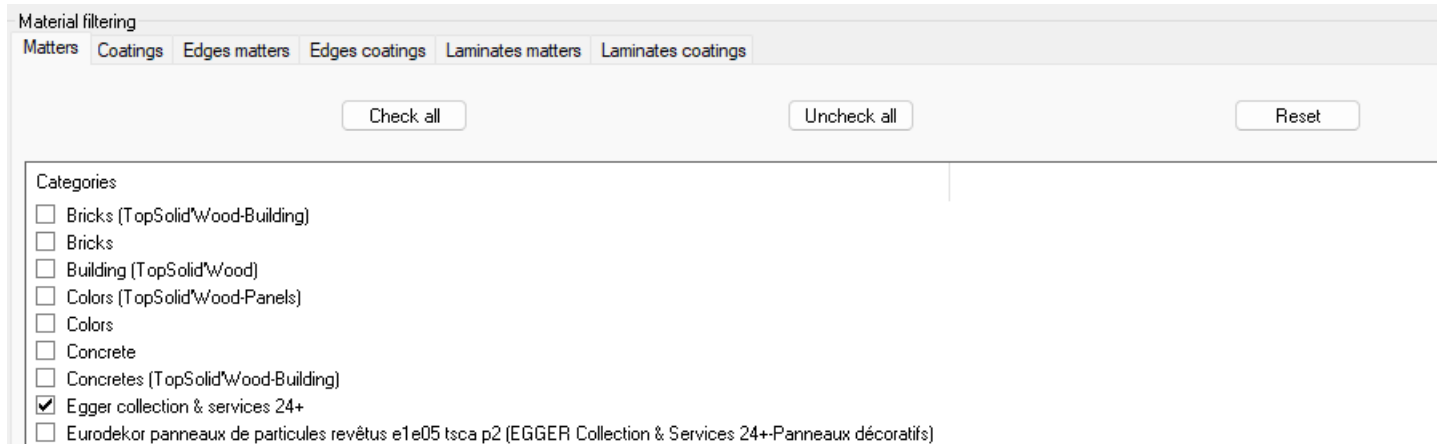

Result as shown in the part definition dialog box.

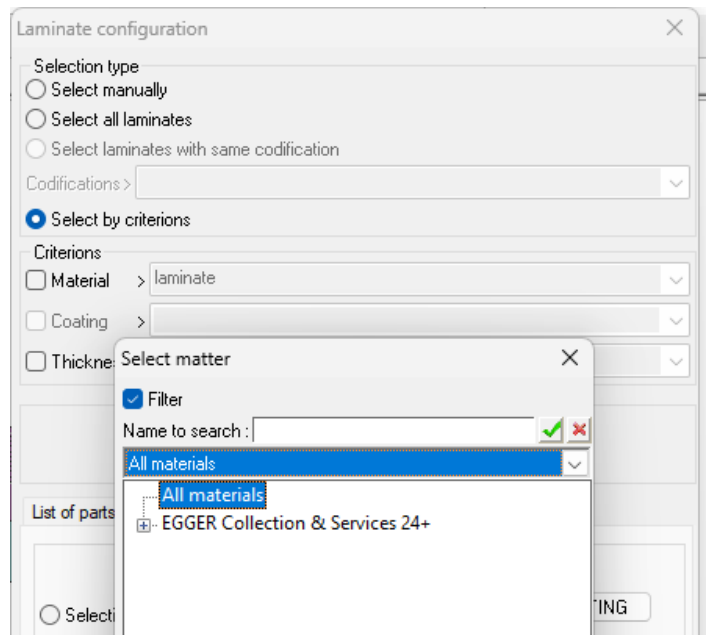

Result as shown in the laminate configuration after filtering laminate materials

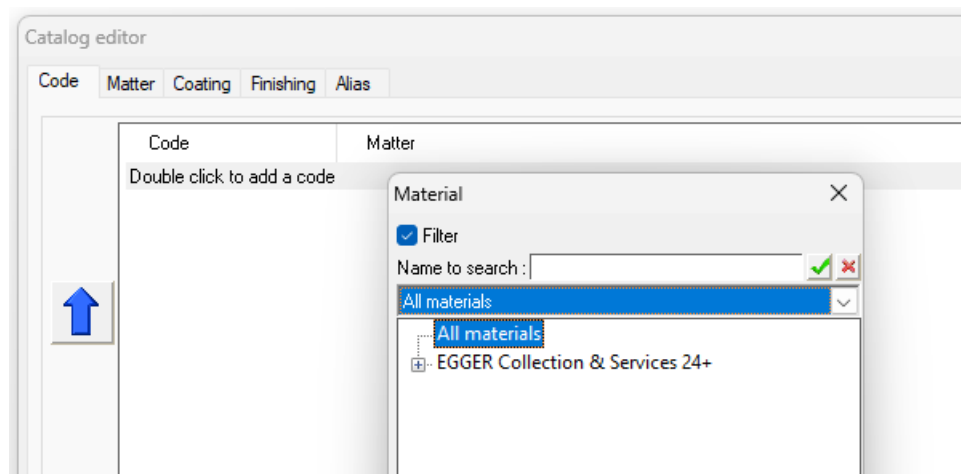

Result as shown in the catalog editor.

Selective component hiding

A new configuration keyword, **D_COMPO_INVISIBLE**, lets you hide specific component families, types, or variants within libraries. This feature helps you simplify the display and limit access to elements that should not be used directly from the standard inclusion dialog.

For example, the standard files for profiling tools and edge-banding tools are intended to be used only through the dedicated profiling and edge-banding commands. Therefore, displaying them in the standard inclusion dialog is unnecessary.

Add this keyword to a library's **lib.cfg** file to control which elements are visible in selection interfaces (such as libraries or the interchange feature):

```
D_COMPO_INVISIBLE [Family] [Type] [Variant]
```

```
lib.cfg
D_COMPO_OBSOLETE      assembly      tongue tongue
D_SH_OP_ZWOO_SHAPING_FILTER_SLOT  wood tool      blades
D_SH_OP_ZWOO_SHAPING_FILTER_SLOT  wood tool      mill
D_SH_OP_ZWOO_SHAPING_FILTER_FOLD  wood tool      blades
D_SH_OP_ZWOO_SHAPING_FILTER_FOLD  wood tool      mill
D_SH_OP_ZWOO_SHAPING_FILTER_MOULDING wood tool
D_COMPO_INVISIBLE    assembly
D_COMPO_INVISIBLE    assembly      Advanced kits
D_COMPO_INVISIBLE    assembly      Advanced kits  Dowels and Cams
```

Examples:

- To hide the entire **Assembly** family: `D_COMPO_INVISIBLE assembly`
- To hide only the **Advanced kits** type in the **Assembly** family: `D_COMPO_INVISIBLE assembly Advanced kits`
- To hide a specific variant in a given family: `D_COMPO_INVISIBLE assembly Advanced kits Dowels and Cams`

Note: This filtering does not affect interchange actions or sub-component changes.

Multi-selection of driver blocks for handle modification

The driver block modification command now supports multi-selection. This allows you to apply the same handle modification to multiple driver blocks in a single step.

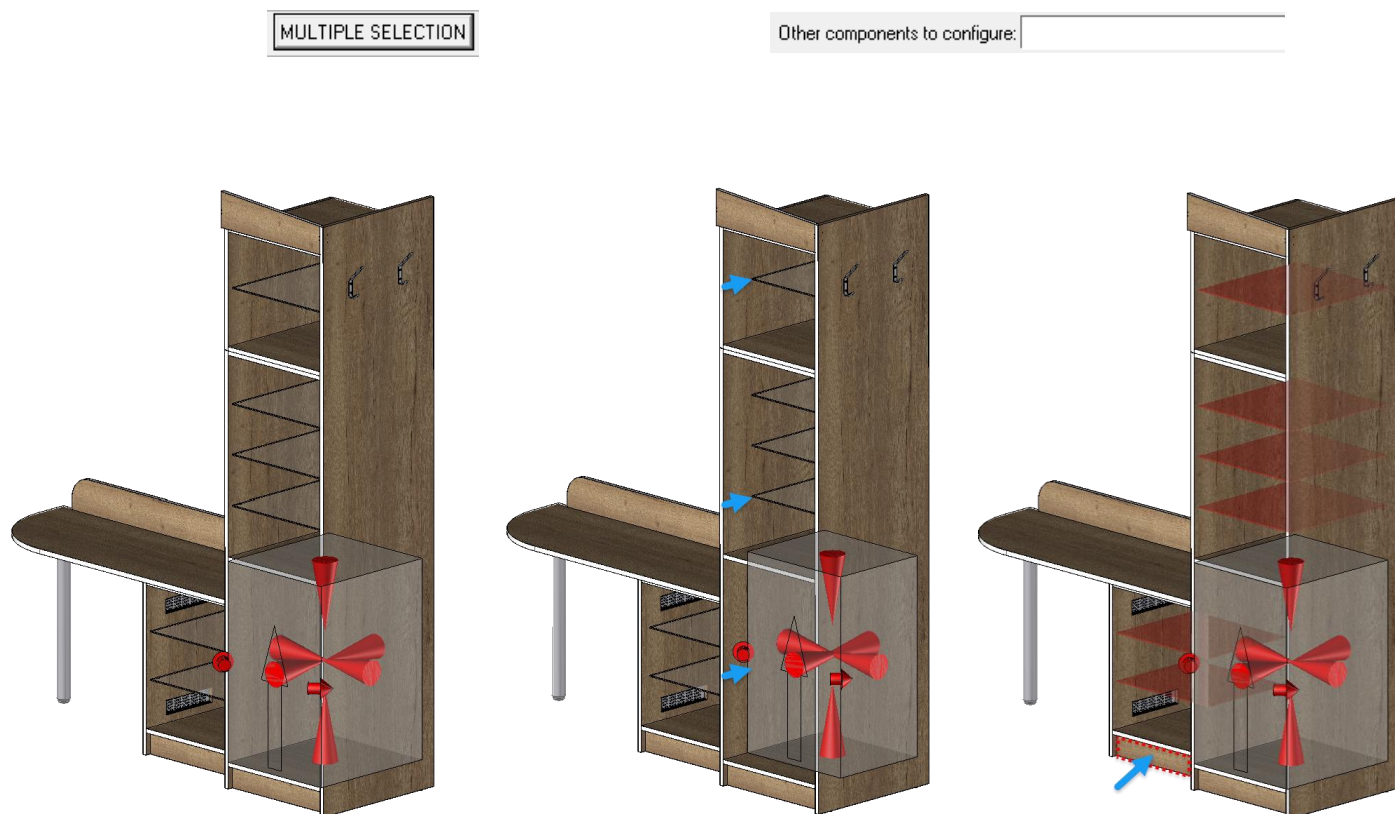

Behavior

- After selecting the handle you want to modify, click on **Multiple selection** to select all the relevant driver blocks.
- If there are several instances of the same component, click on the **Identical components** button to automatically select all of them.

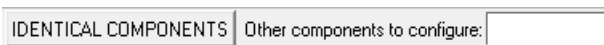

Fixed overdimension management on panels

Three new configuration keywords let you define fixed overdimensions for panel entities:

- `ZWOO_PANEL_PROP_OVERLENGTH_VALUE` : length overdimension
- `ZWOO_PANEL_PROP_OVERWIDTH_VALUE` : width overdimension
- `ZWOO_PANEL_PROP_OVERTHICKNESS_VALUE` : thickness overdimension

By default, these values are set to 0 mm. You can change them to automatically apply a different overdimension (for example, 5 mm). This feature is especially useful in production environments where overdimensions are added to the finished dimensions of the panel, including the edges.

Component configuration in neutral mode

In neutral mode, clicking on a component now displays the **Configure** option. This option opens the same dialog box used for the visual configuration of standard components.



Note: With this improvement, configuration is now accessible from any context.

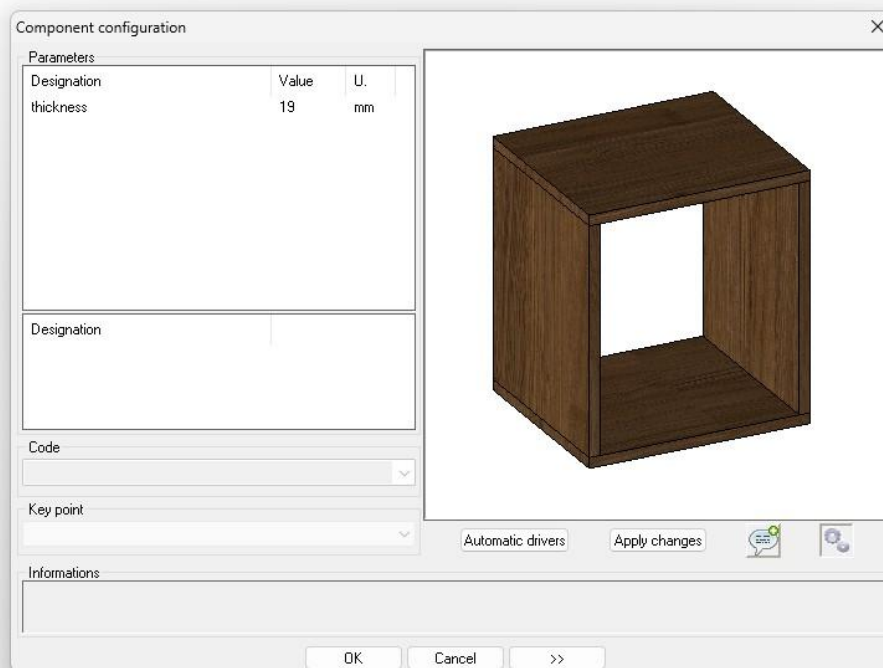

Advanced STEP export

The **Export geometries** command now allows you to export directly to the STEP format. You can choose between two export modes:

- Export all parts into a single STEP file
- Create a separate STEP file for each part or shape



Additionally, when exporting an entire project or a selection of parts, **TopSolid** automatically assigns a unique random color to each exported part, based on its matter and coating combination. This visual classification helps you quickly identify groups of similar parts and makes it easier to apply a common matter or texture.



STEP export from TopSolid 6.27.

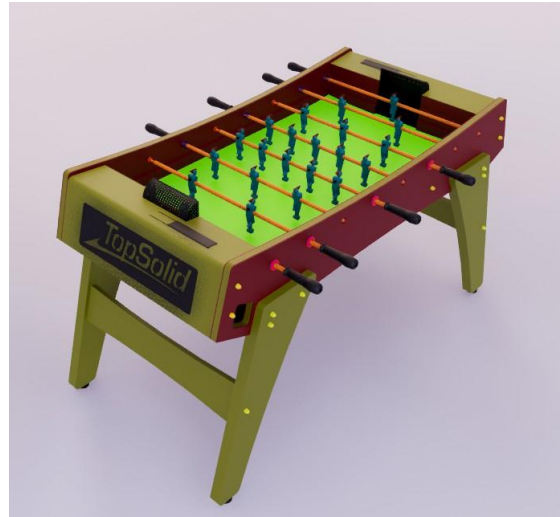

STEP export imported into TopSolid'Virtual.

When exporting to STEP, the software automatically applies different colors to parts according to their matter and coating. When you import the STEP file into **TopSolid'Virtual** or any other 3D viewer, these colors improve readability, make selection easier, and support content reuse.



Matter added to one of the parts.



Result after matter application.

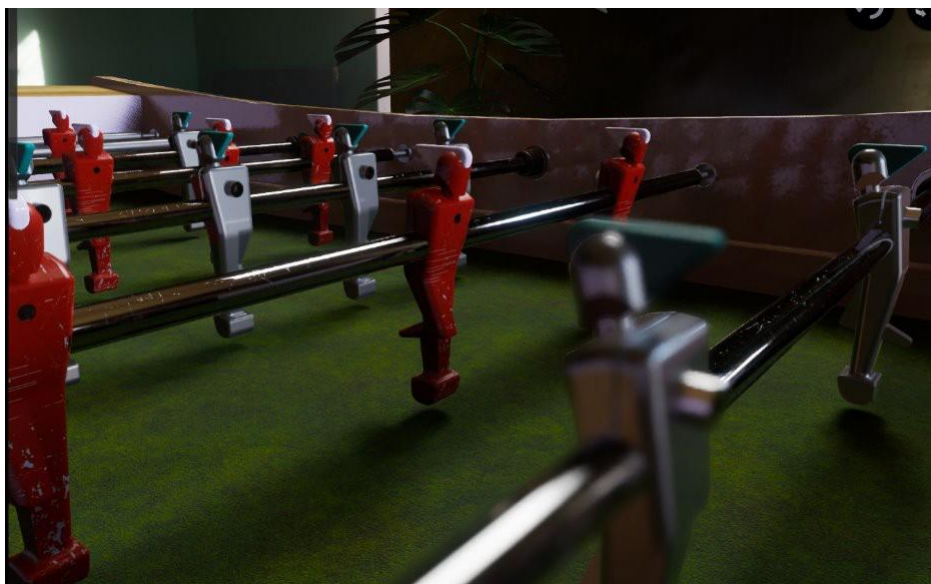

Hybrid selection in the edge configuration

In the edge configuration, the **Criteria** and **Criteria of support** sections are now combined into a single section. You can now select and combine all available criteria—such as matter, coating, type, code, and height—in one place. This change allows for more precise and flexible searches, without the need to switch between different sections.

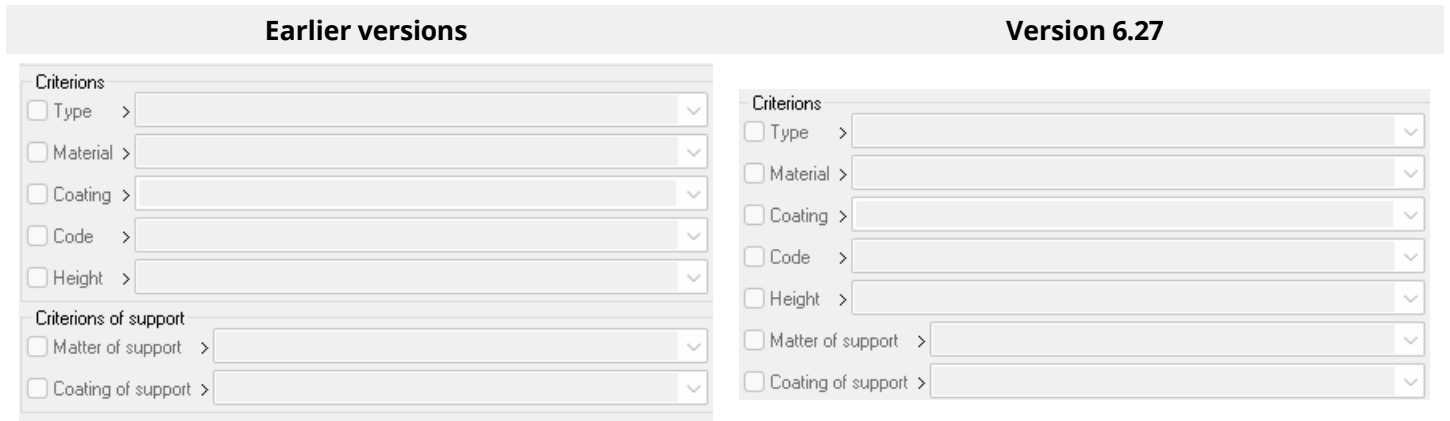

Multiple validation of component drivers

When you insert a component, if **TopSolid** detects that the insertion document contains drivers with the same names as those in the component being inserted, an **OK for all** button is now displayed.

This button automatically assigns the corresponding values from the insertion document to the component's drivers.

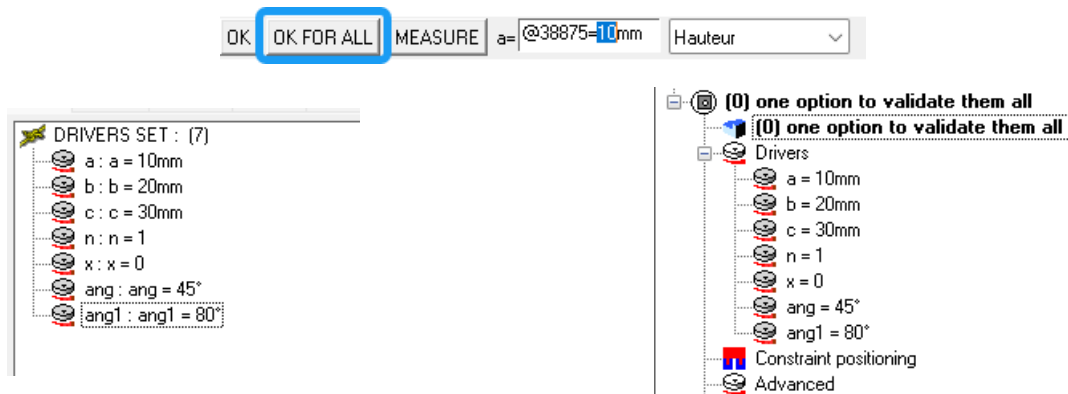

Serial copy in loop mode

The serial copy feature is now available for curves created using the **Curves > Copy edge** command in **Loop** mode.

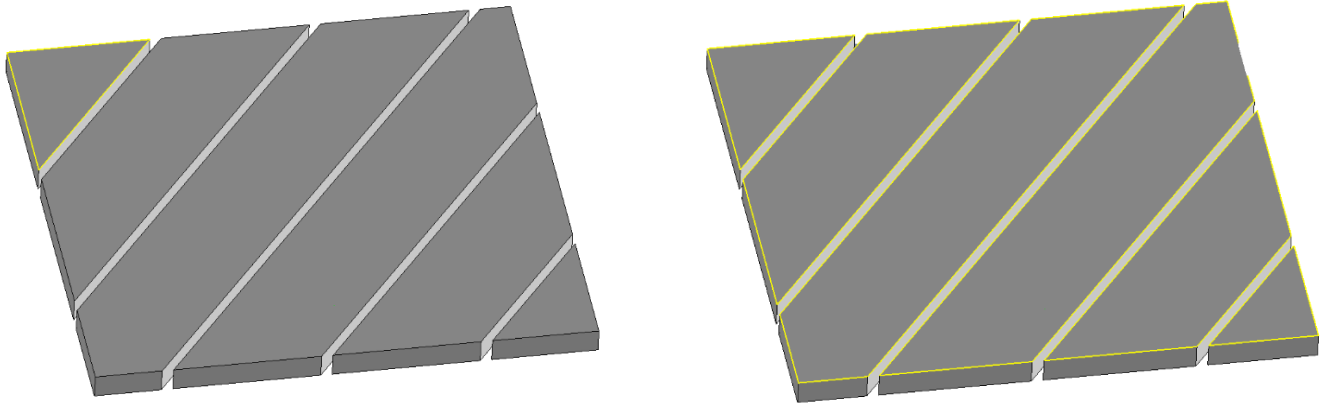

You can access this command from the contextual menu by right-clicking on any eligible loop.

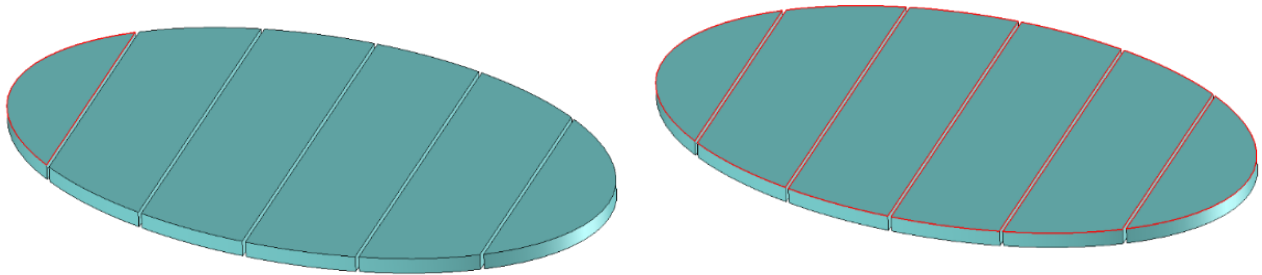

Face straightening during swept curve trim

In the **Shape > Trim** command, when using the **By sweeping curve** mode, a new option is available to automatically straighten the faces of a solid based on the sweep curve plane.

Straighten faces= YES

Straightening mode= BY 2 POINTS
 BY 2 POINTS
 FIXED DIRECTION
 MIDDLE TANGENT

There are three available straightening modes:

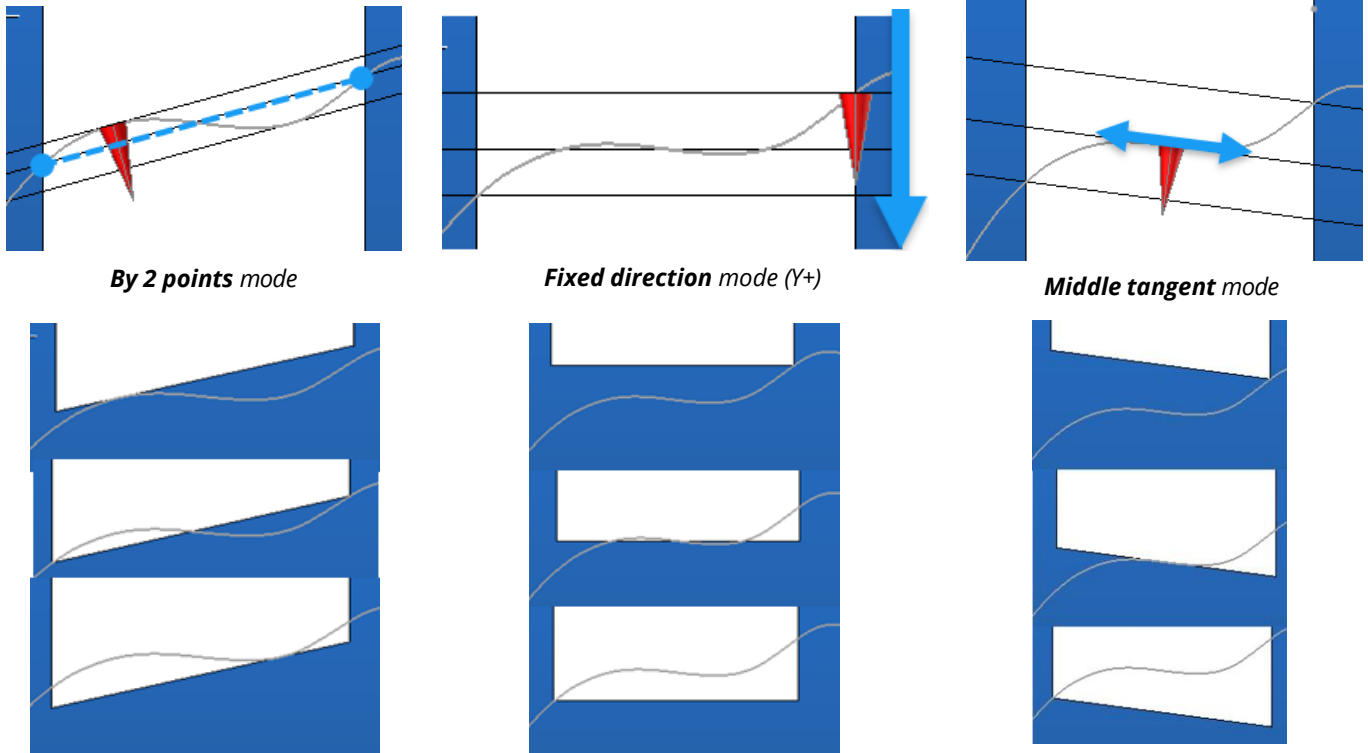

Automatic connection of Boolean parameters for standard components

The **Automatic drivers** button now automatically connects the Boolean drivers of a component to those in the inclusion document when they have the same name. This feature removes the need for manual linking.

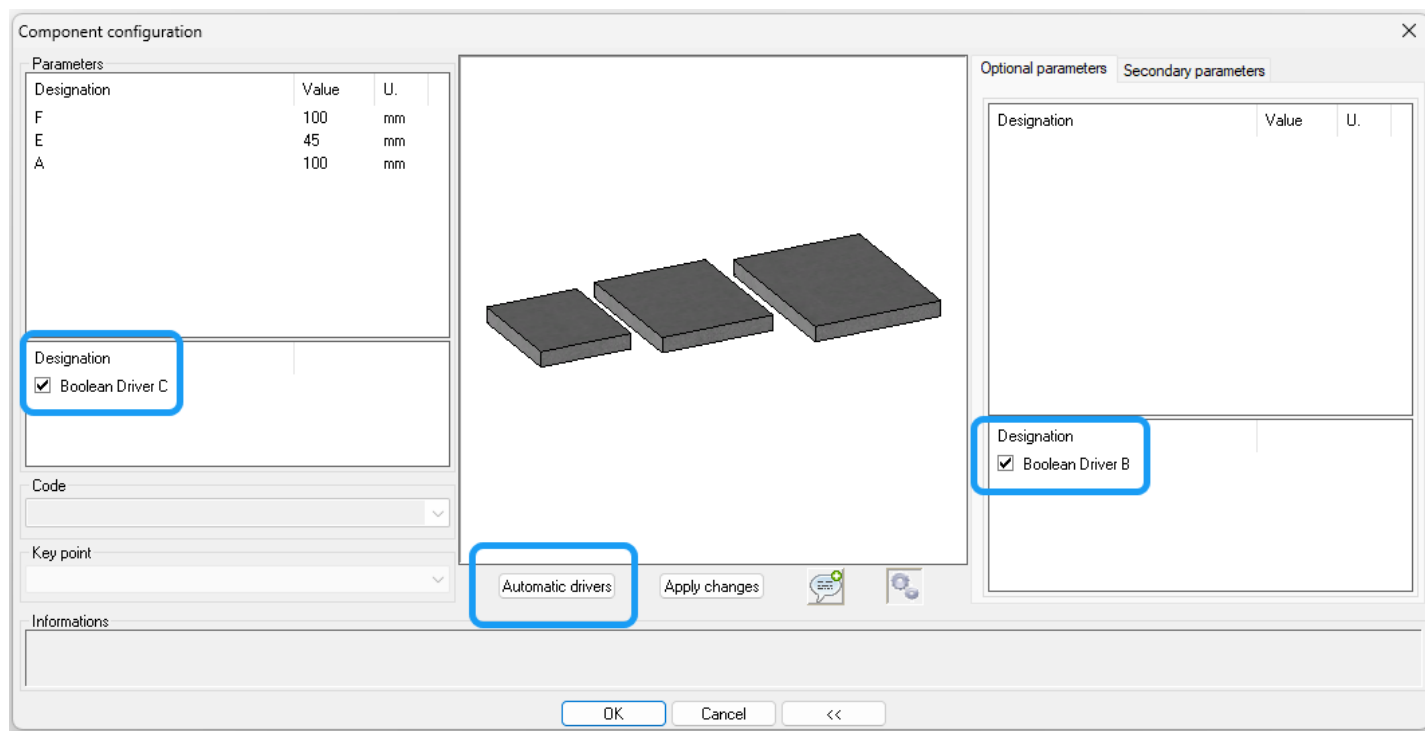

New inside/outside mode for offset curves

Creating offsets on a closed curve now features a dedicated mode that allows you to precisely control whether the offset is applied to the inside or outside of the curve.

This improvement offers greater geometric stability, especially for components that depend on geometric drivers.



Previously, the direction was determined by the mouse position during creation. When using geometric drivers, this approach could cause unstable behavior due to factors such as:

- the current coordinate system,
- the origin of the curve.



You can now reliably select the construction side of the curve, regardless of the coordinate system or the original context.

Separation of merged panel drivers

This feature enables you to separate panel drivers that share the same parameters.



When two or more panels use a shared driver, you may need to separate them to restore independent operation for each panel.

The new contextual **Separate driver** command allows you to detach merged panel drivers in a single step.

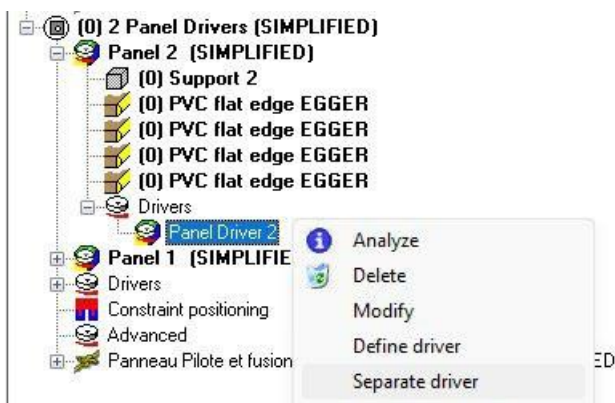

This action unlinks the merged driver, restoring full autonomy. The driver will then function independently, without affecting or being affected by the elements it was previously connected to.

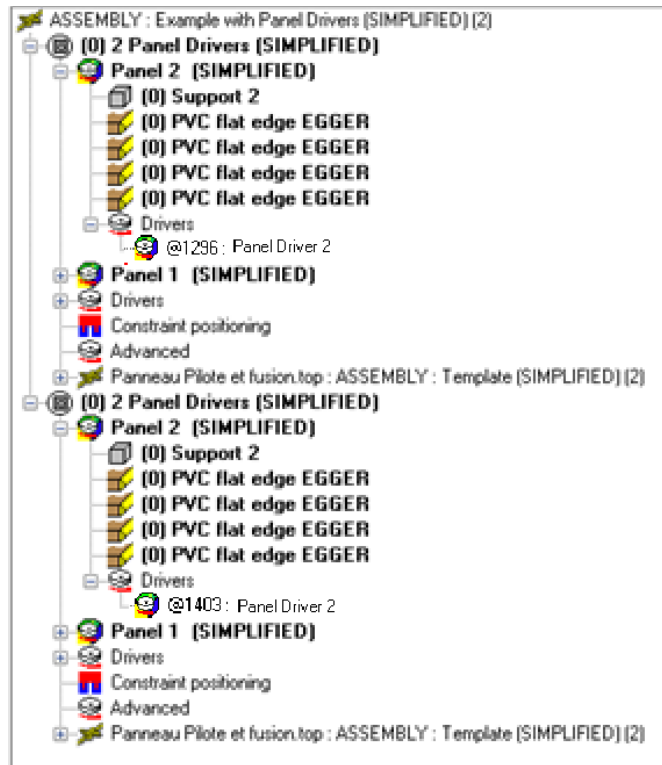

Multi-folios drafting template

The **Multi draft** command now supports templates with multiple folios. This enhancement provides greater flexibility when generating drawings automatically.

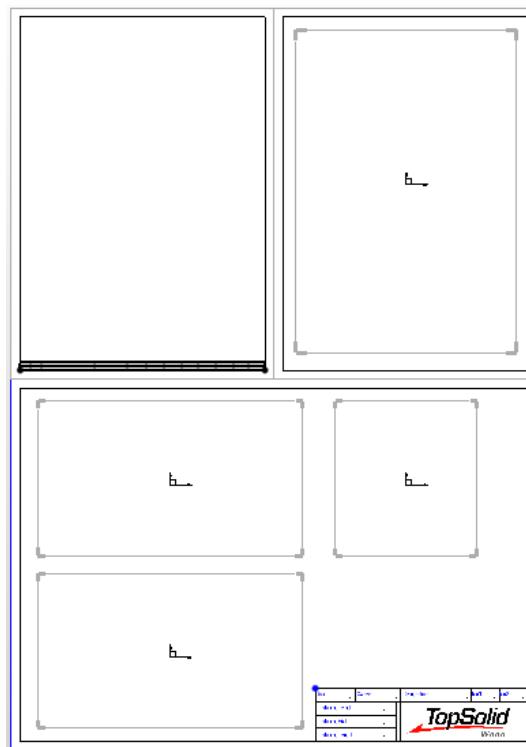

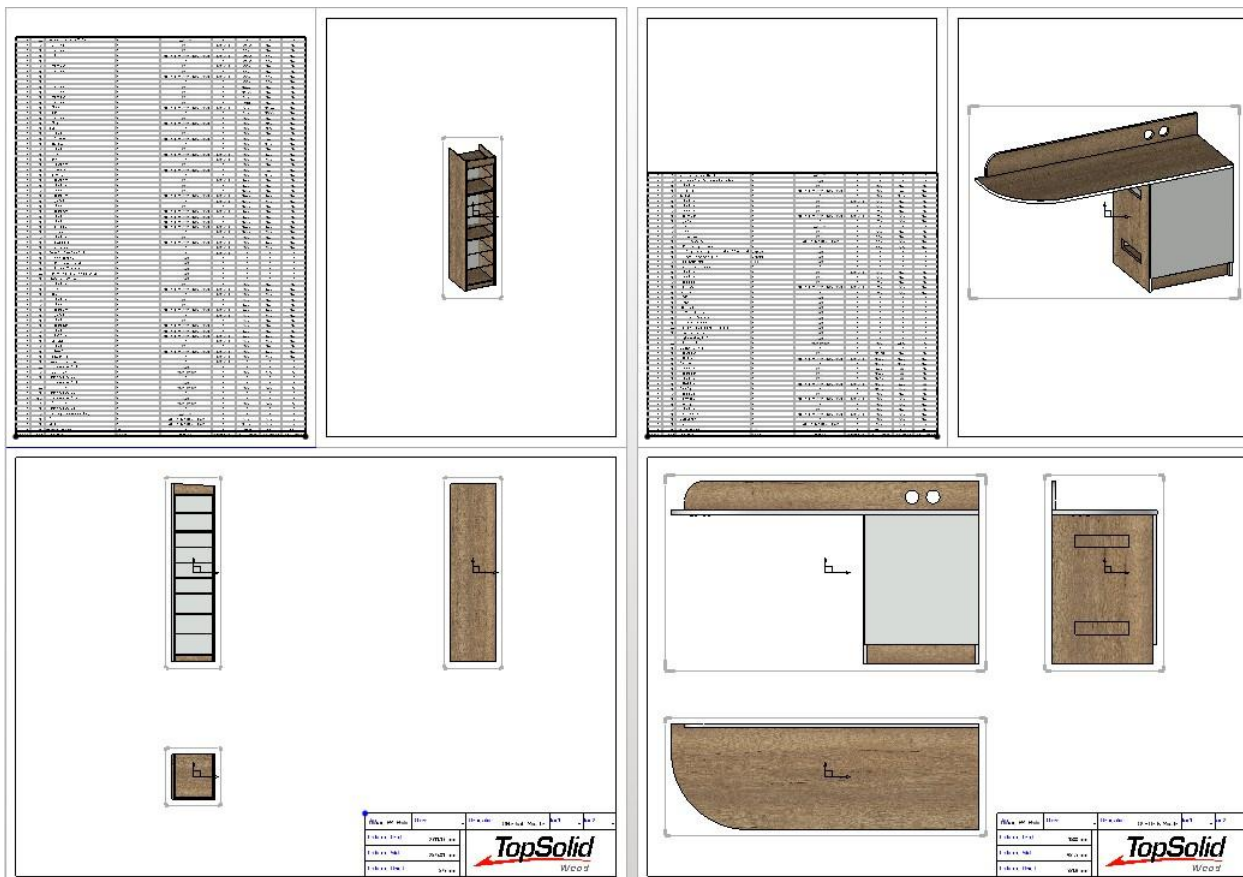

Shading of identical parts in identification views

During multi-drafting, all identical parts that are grouped together during sorting are now displayed in shaded mode at the same time. Previously, only the first part in the group was shown as shaded, which could make it harder to visually identify similar parts.

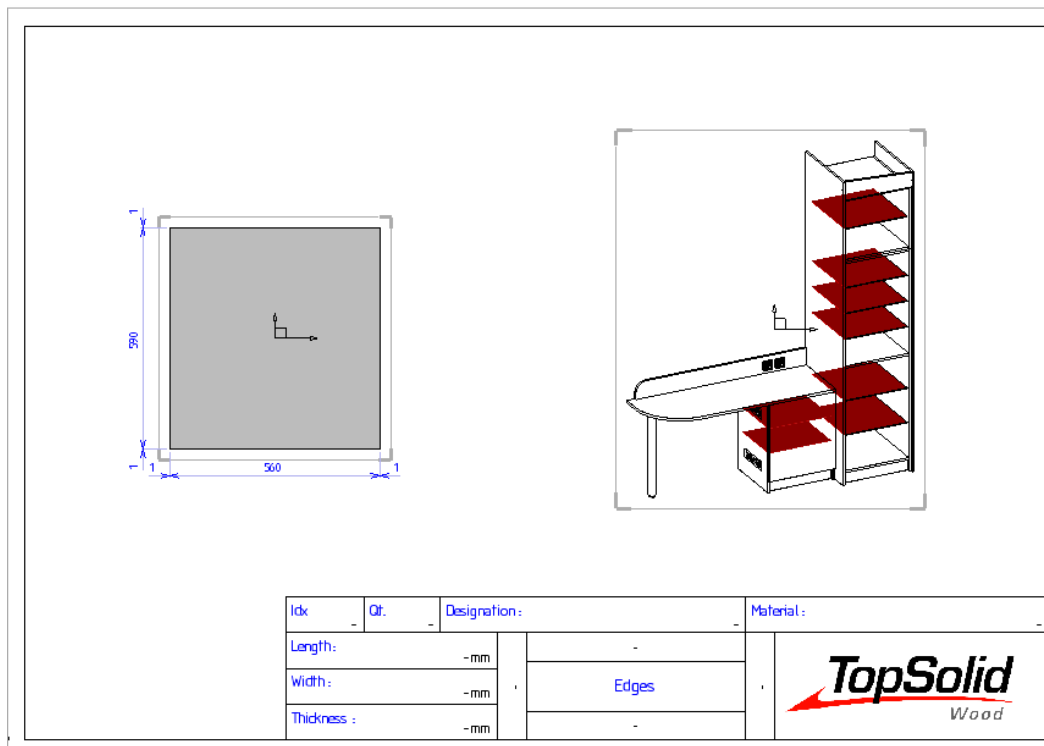

BOM: Advanced indication of edge/laminate presence or absence

You can now use a specific symbol to indicate whether edges or laminates are present or absent in the bill of materials.

To configure this, manually add the following configuration keywords to the **topzwoo.cfg** file. Replace the value 1 with the character you want to use:

- To indicate the absence of edges: `ZWOO_D_ELT_CODIFICATION_BOM_NO_EDGE_CHAR 1`
- To indicate edges without codification: `ZWOO_D_ELT_CODIFICATION_BOM_SEP 1`

Partial loading of standard components



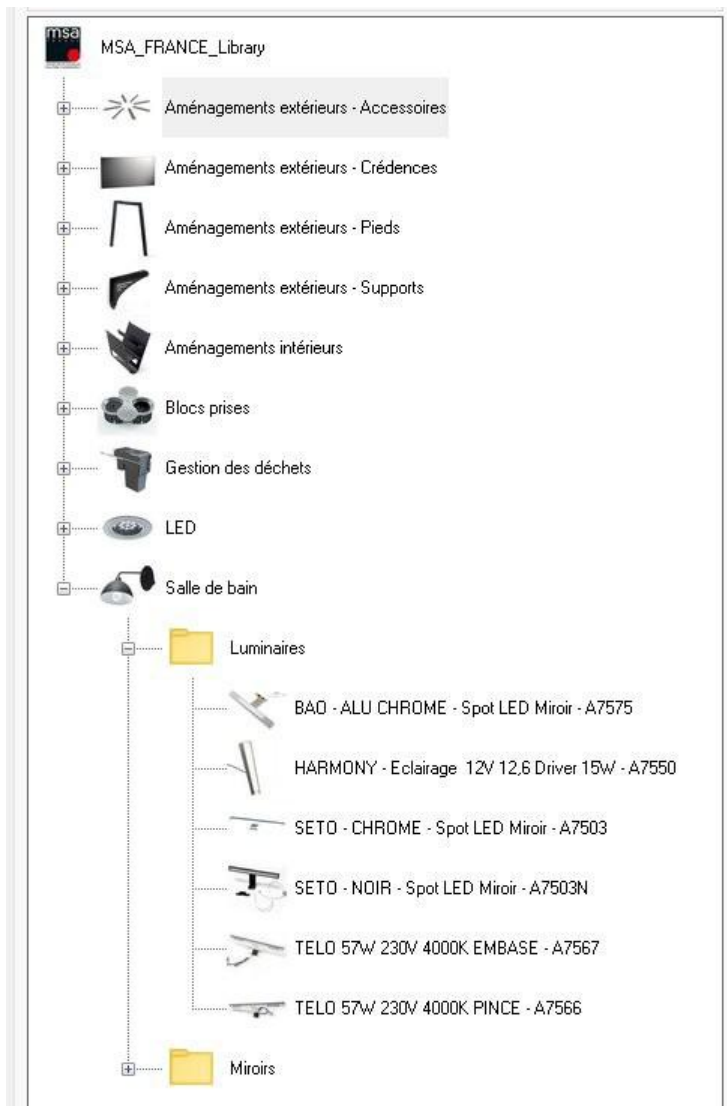



Standard components are now loaded only for expanded nodes. This change improves display performance and reduces loading times.





Optimized matter previews for neutral mode modifications

When you modify a component in neutral mode, the BOM property that displays matters and coatings now automatically uses the matter preview.

Note: This optimization significantly reduces file size.

SUPPLIER	REFERENCE	MATTER	PREVIEW
-	-	acier	
EGGER	-	W1300 - ST9	
-	-	Verre fenêtre	
-	-	PVCU	
EGGER	-	H1180 - ST37	
-	-	420 HV	

SUPPLIER	REFERENCE	COATING	PREVIEW
-	-	nickel	
-	-	blanc mat	
-	-	-	

New segment mode for curve division

A new division mode is now available for curves made up of lines, arcs, or B-splines.

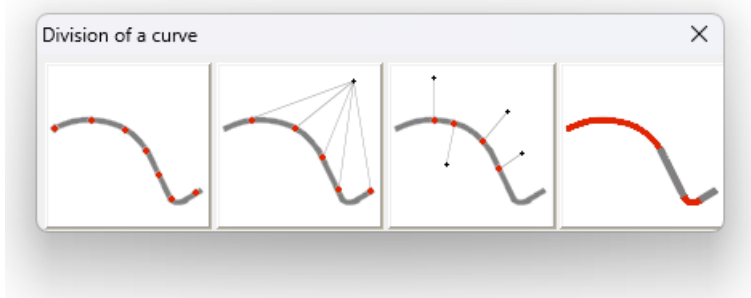

This mode lets you cut curves directly at the junctions between segments. You can also adjust the cut position by setting an overlap value, which can be either positive or negative.

There are now two available modes:

- **Centered mode:**

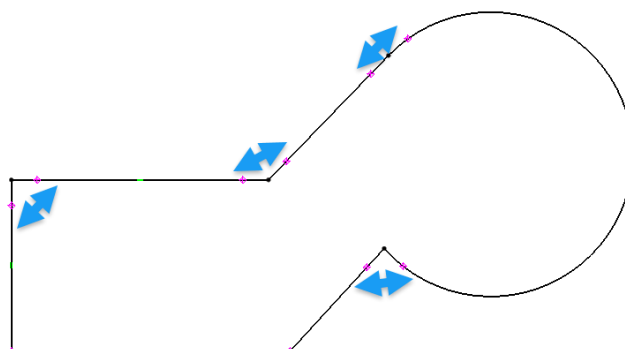

- **Segment mode:** You can set the cutting priority based on the overlap value. Negative values give priority to arcs, while positive values give priority to lines.

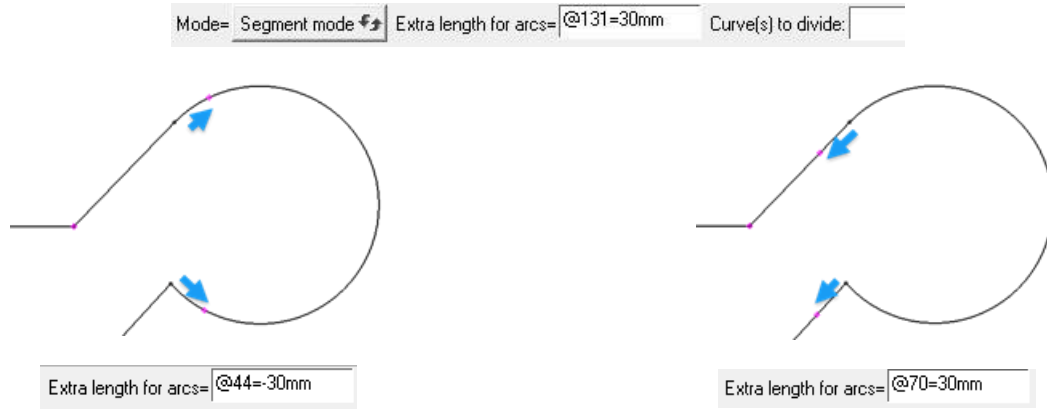

Housing manager

Accessible from the **Shape > Other shapes** menu, the new **Housing manager** command helps you manage, organize, and merge construction volumes created by repetitions. This tool provides flexible options for grouping, adjusting, or combining multiple volumes efficiently.

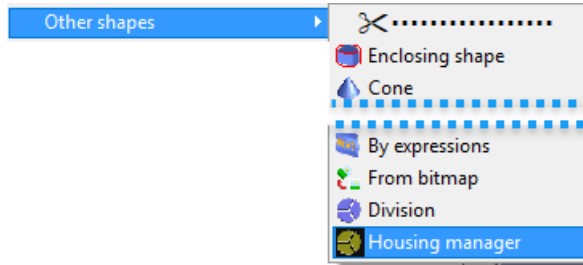

The **Volumes to merge** option allows you to merge adjacent volumes into a single volume, making it easier to manage complex constructions.

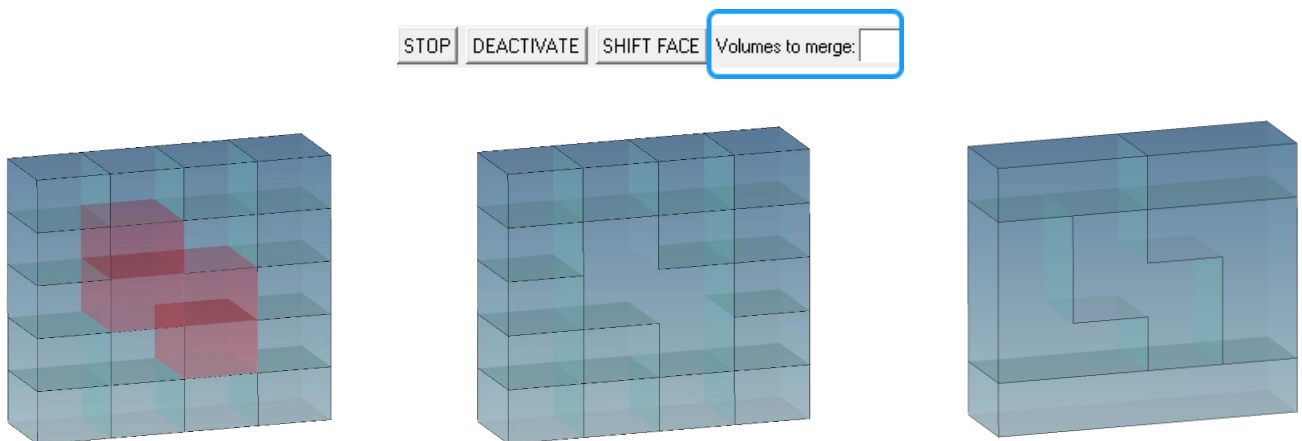

The **Deactivate** button lets you deactivate selected copies.

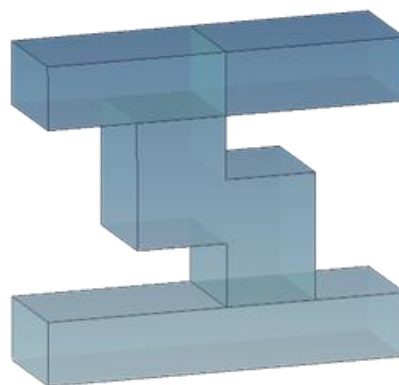
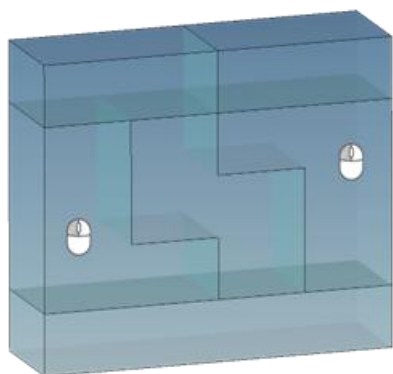

The **Shift face** button allows you to move the faces of multiple copies at once.

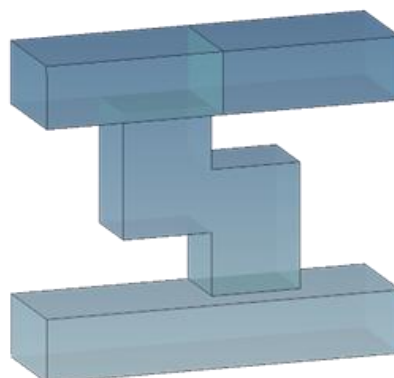
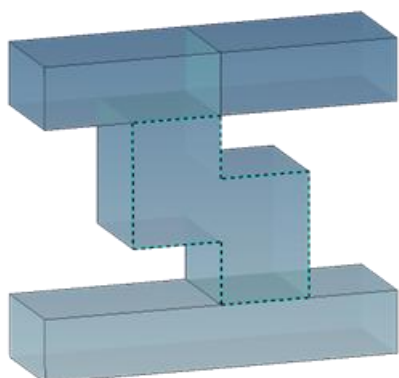
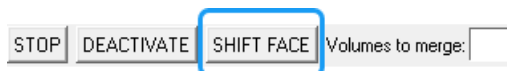

Interfaces

Adjusting distances in woodWOP and Maestro configurations

In the **woodWOP** and **Maestro** configurations, the default values for the following settings have been updated:

- **Calibration approach distance** exported to **woodWOP**: 10 mm.

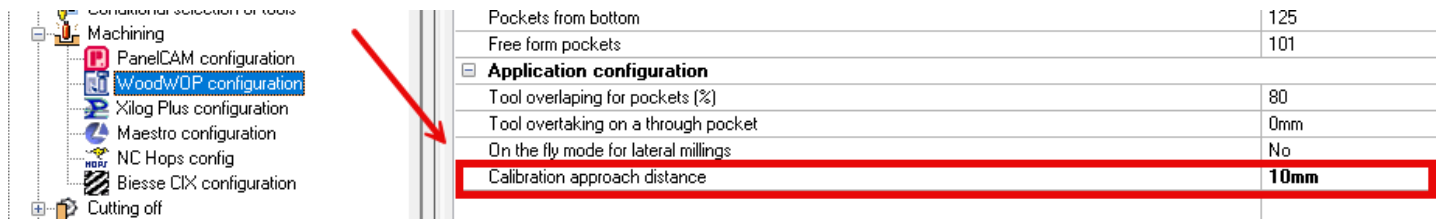

Pockets from bottom	125
Free form pockets	101
Application configuration	
Tool overlapping for pockets [%]	80
Tool overtaking on a through pocket	0mm
On the fly mode for lateral millings	No
Calibration approach distance	10mm

- **Drilling security distance** exported to **Maestro**: 10 mm.

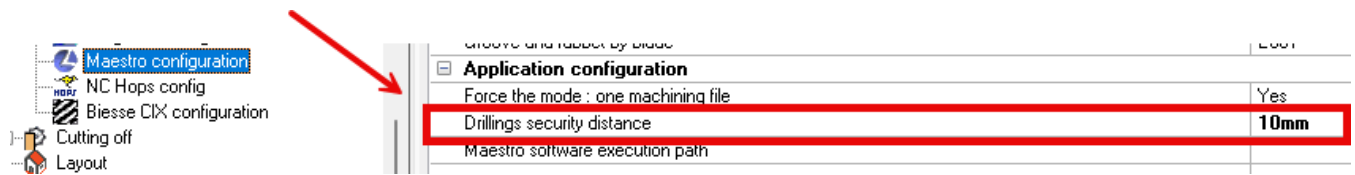

Drillings and robot by hand	Yes
Application configuration	
Force the mode : one machining file	Yes
Drillings security distance	10mm
Maestro software execution path	